

# Technical data sheet



## Product features

### Chilled display unit GN 3-1/1 bottom cover, opening to the sides, Hemlock

<b>Model</b>	<b>SAP Code</b>	00012129
--------------	-----------------	----------



- Buffet type: PLATINUM - dynamically cooled showcase
- Device properties: Chilled
- Number of GN / EN: 3
- GN / EN size in device: GN 1/1
- GN device depth: 200
- Minimum device temperature [°C]: 4
- Maximum device temperature [°C]: 8
- Opening of device: Sliding to the sides

<b>SAP Code</b>	00012129	<b>Loading</b>	230 V / 1N - 50 Hz
<b>Net Width [mm]</b>	1169	<b>Number of GN / EN</b>	3
<b>Net Depth [mm]</b>	760	<b>GN / EN size in device</b>	GN 1/1
<b>Net Height [mm]</b>	1688	<b>GN device depth</b>	200
<b>Net Weight [kg]</b>	148.00	<b>Minimum device temperature [°C]</b>	4
<b>Power electric [kW]</b>	0.247	<b>Maximum device temperature [°C]</b>	8

# Technical data sheet



Technical drawing

Chilled display unit GN 3-1/1 bottom cover, opening to the sides, Hemlock

Model

SAP Code

00012129

A= ELECTRICAL CONNECTION  
 D= WATER DISCHARGE Ø16  
 E= GAS CONNECTION Ø8 Ø10  
 F= WATER BOX

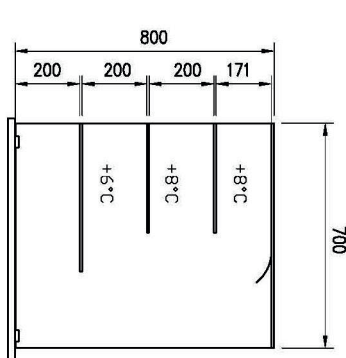
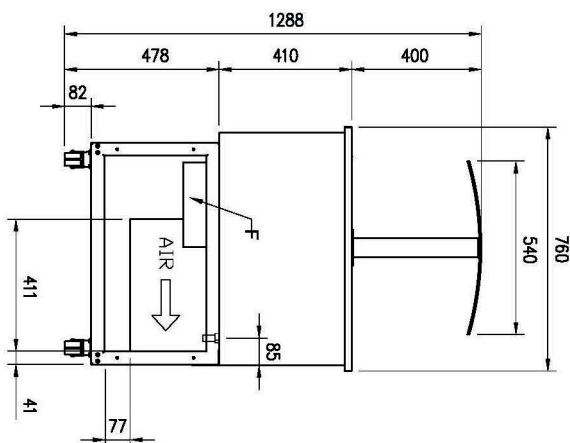
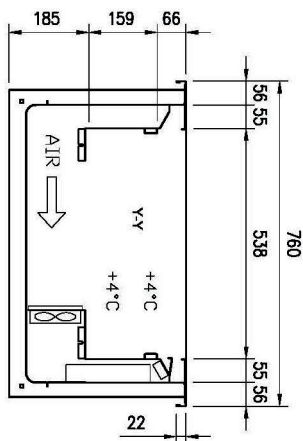
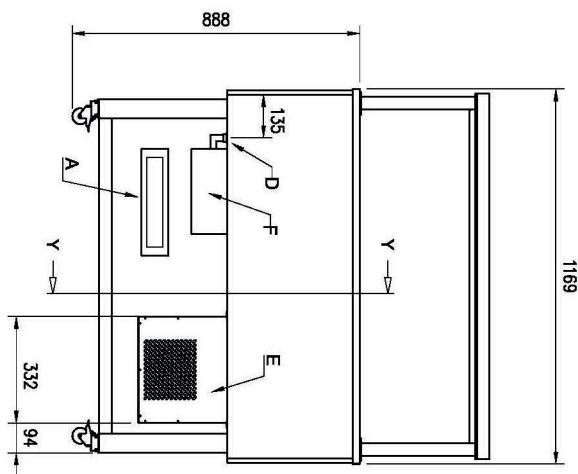
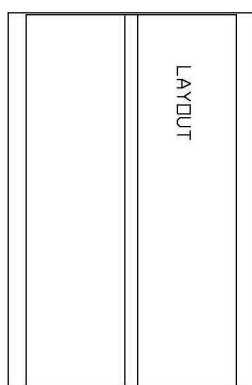

PLATINUM

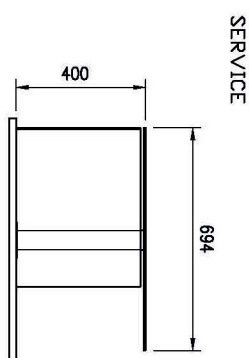

SERVICE

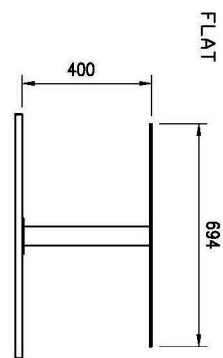

FLAT

# Technical data sheet



## Product benefits

### Chilled display unit GN 3-1/1 bottom cover, opening to the sides, Hemlock

Model

SAP Code

00012129

1

#### Dynamic cooling

constant temperature in all places of the refrigerated space

- greater hygienic safety of chilled food

2

#### LED lighting

minimal energy consumption

- economical lighting
- attractive appearance

3

#### Surface height regulation

a large range of the height of the bottom surface of the display case

- greater variability of product storage
- space saving

4

#### Braked travel wheels

easy handling

- the possibility to easily move the display case during operation as required

# Technical data sheet



## Technical parameters

### Chilled display unit GN 3-1/1 bottom cover, opening to the sides, Hemlock

**Model**

**SAP Code**

00012129

**1. SAP Code:**

00012129

**2. Net Width [mm]:**

1169

**3. Net Depth [mm]:**

760

**4. Net Height [mm]:**

1688

**5. Net Weight [kg]:**

148.00

**6. Gross Width [mm]:**

1233

**7. Gross depth [mm]:**

860

**8. Gross Height [mm]:**

1830

**9. Gross Weight [kg]:**

182.30

**10. Device type:**

Electric unit

**11. Buffet type:**

PLATINUM - dynamically cooled showcase

**12. Device properties:**

Chilled

**13. Exterior color of the device:**

Hemlock

**14. Power electric [kW]:**

0.247

**15. Loading:**

230 V / 1N - 50 Hz

**16. Number of GN / EN:**

3

**17. GN / EN size in device:**

GN 1/1

**18. GN device depth:**

200

**19. Minimum device temperature [°C]:**

4

**20. Maximum device temperature [°C]:**

8

**21. Opening of device:**

Sliding to the sides

**22. Interior lighting:**

No